



ARCHITECTURAL
GRATES + DRAINS



SDiPS

Slot Drain



This is a Punched Slot Stainless Steel Grate component to fit the Slot Drain SD90

This is the newest addition to the original Slot Drain.

Please be aware that depending on the installation environment, for a pool installation or close to a surf beach, you may need to have your stainless steel grates electropolished.

Code SDiPS
Range Slot Drain
Grate Style PS
Category Components
Steel Grade 316

SPECIFICATIONS + DIMENSIONS

Channel Width	30mm
Channel Depth	Adjustable
Length(s)	1000mm 1500mm
Outlet Size	N/A

STORMTECH COLOUR FINISHES

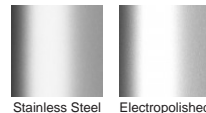

Electroplate finishes subject to natural variation with time and local environment. Factors such as pools/surf beaches may require electropolishing. Contact us for suitability.

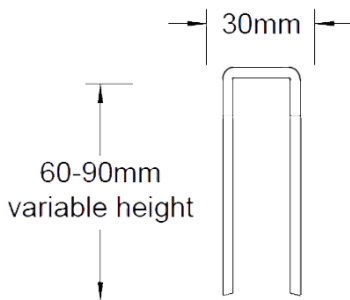

PRODUCT APPLICATIONS

- Balcony Drainage
- Commercial Drainage
- Courtyard / Patio Drainage
- Driveway Drainage
- Pool and Spa Area Drainage
- Paved Area Drainage
- Special Needs Drainage

Grates longer than 1500mm supplied in sections. Tile Inserts longer than 1200mm supplied in sections. Channels over 3000mm supplied in sections with joiner. +/-2mm tolerance on dimensions.

Copyright © Stormtech Pty Ltd. Patent 733361. Drawings not to scale, please use dimensions shown.
Downloaded 15/04/2026 (please check for updates)



Visit stormtech.com.au
for tools + inspiration.

Phone **1300 653 403**

Email info@stormtech.com.au